

INDUSTRY STANDARD 'A' RANGE AMT SERIES SIGNAL TRANSMITTERS

The range includes ATA trip amplifiers, ACC arithmetic units and AGS special products
Please see our other catalogues

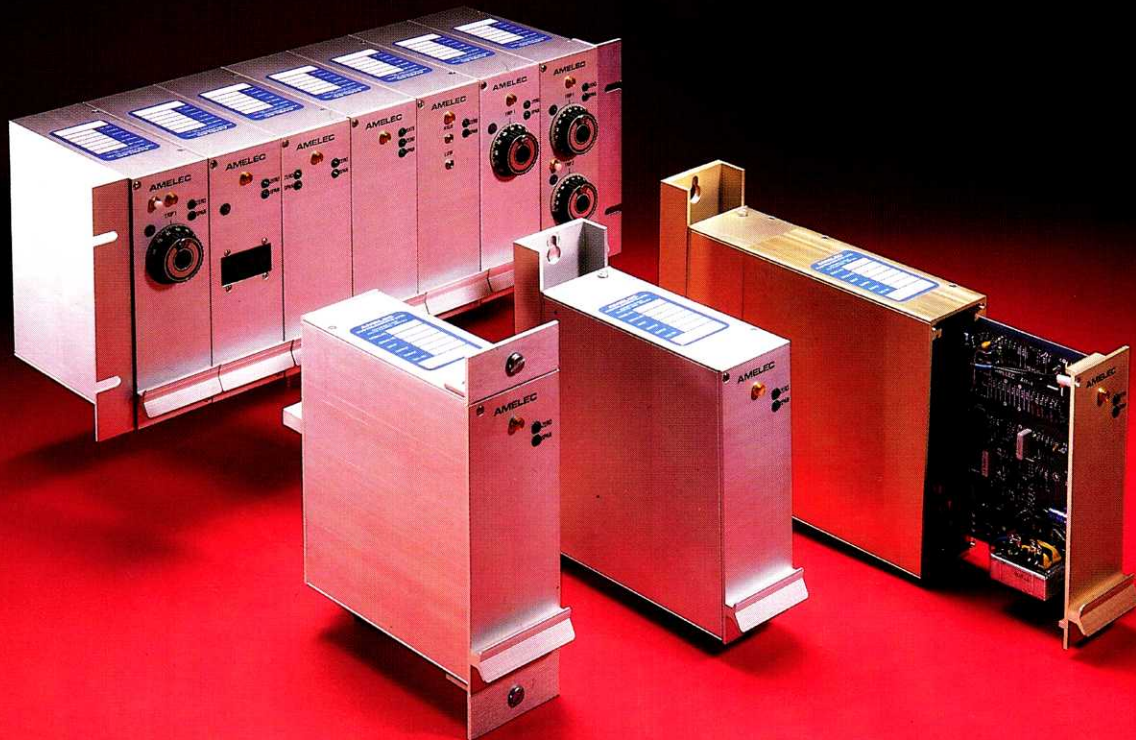

- Suitable for input from thermocouple, millivolt, RTD, sildewire or process signals.
- Models available for single output, double output (optionally isolated), single trip, double trip or two completely isolated transmitters within one enclosure.
- Trip points set by single turn lockable dial with 100mm scale length. Other controls easily accessible through the front panel.
- Supply voltages of 120VAC, 240VAC, or 24VDC available at no additional cost. All units individually fused and front panel supply indicators fitted.
- Digital indication of input and trip points may be specified, scaled as a percentage of input span or in engineering units.
- RFI protection to BS6667, Part 3 available for all units.
- Manufactured and tested to BS EN ISO 9002
- AMELEC standard 10 year guarantee.

Specification

INPUT DATA

Input source

For details see individual specification

Open circuit response

For details see individual specification.

Input impedance (Voltage input)

>1Mohm at amplifier input. This will be shunted by burnout drive or input conditioning components.

SUPPLY DATA

Power supplies

AC models	115VAC \pm 20% 230VAC \pm 20%
DC models	24VDC \pm 2.5V
2 wire	12 - 60VDC

Consumption

Single transmitter	3VA
Double transmitter	4VA
Transmitter/single trip	4VA
Transmitter/double trip	5VA
Dual channel transmitter	6VA
2 Wire transmitter	250mW

OUTPUT DATA

Output signals (Each output)

Standard units.

Any constant current from 0-100uA to 0-20mA (at up to 20V loop) or any constant voltage from 0-1V to 0-10V (at up to 20mA loading). Double transmitters need not necessarily be specified for similar outputs.

2 Wire units.

4-20mA or 10-50ma into up to 48V loop when operated from a 60VDC power supply.

Response time

<400mSec. Unless otherwise stated

Relay specification

DP/DT for each trip, unless otherwise stated. Contacts are rated at 250VAC, 5A, 100VA (Resistive).

Relay function

Selected by PC link. Default is normally energised, relay to de-energise on trip (fail safe operation).

Relay status

Indicated by a red LED for each trip, mounted on the front panel. Lit when relay is energised.

Controls

ZERO	\pm 25%
SPAN	\pm 50%
TRIP (When fitted)	0-100%
DEADBAND (When fitted)	1-20%

CONDITIONS

Ambient temperature

Working	-20°C to +60°C
Storage	-40°C to +70°C

Humidity

From 5% to 95% R.H.

Vibration

1g at 15Hz to 150Hz.

ELECTRICAL STANDARDS

Insulation Input-output-contacts-earth-channel

1000V RMS continuous. 2000V for 20uSec. Derate to 500VDC for option 'K' enclosures.

Fusing

Power supply fused. Spare fuse mounted on PCB.

WIRING AND MOUNTING

Terminals

For conductors up to 2.5mm².

Weight

1.5kg approximately, when mounted in enclosure.

Position

Any position is acceptable.

Types of mounting

Wall, panel, single end access and rack. Precision extruded aluminium construction. Standard units are Anodised, option 'K' units are 'Alochromed'. An IP65 enclosure is also available for 2 wire units only.

Additional protection

Enclosures are available to NEMA 12 oiltight, NEMA 4 watertight and IP54 for N-protection.

PERFORMANCE

Input/output linearity

<0.1% error, unless otherwise stated.

Series mode rejection

<0.1% error for 50Hz input at 5% of span amplitude.

Common mode rejection

<0.1% error for 250V RMS.

Temperature effect on zero

<0.02% per °C.

Temperature effect on span

<0.01% of span per °C or <0.1°C per °C, whichever is the greater.

Temperature effect on suppression/elevation

<0.02% of suppression/elevation per °C.

Supply voltage effect

<0.01% per % input change.

Trip adjustment

Infinitely variable by single turn 260° dial on front panel, calibrated 0-100 and lockable. Alternatively, by multi-turn potentiometer accessible through front panel.

Deadband

Standard 1%. Also available adjustable from 1 to 20% by single turn 260° dial or by multiturn potentiometer.

RFI rejection

Standard enclosures are inherently RFI proof due to their solid aluminium construction. However, for extra protection to BS6667, specify option 'K'.

Permissible input overload

mV input	20V
DC voltage input	200V
DC current input	500%
AC voltage input	200%
AC current input	500%
Resistance input	6V

Transmitters

AMT210 series, thermocouple and millivolt

These units will accept input from any BS4937 and ISA B,E,J,K,S,R,T or Pallaplat thermocouple; or millivolt source.

Thermocouple input units have automatic cold junction compensation.

Normal minimum span 4mV, lower ranges available to special order.

Source resistance up to 1000ohms for specified performance.

Open circuit response may be specified as upscale or downscale.

Input impedance 1Mohm, shunted by burnout drive.

Output proportional to input voltage, or temperature when option 'G' is specified.

Models available

INPUT	Single output	Double output	Transmitter single trip	Transmitter double trip	Double channel
Thermocouple	AMT210	AMT211	AMT212	AMT216	AMT218
Millivolts	AMT213	AMT214	AMT215	AMT217	AMT219

INPUT WIRING

Single channel

TB1

Input + 1

Input - 2

Screen 3

Double channel

TB1

Input 1 + 1

Input 1 - 2

Screen 3

TB2

Input 2 + 1

Input 2 - 2

Screen 3

For output and supply wiring, please turn to page 10.

AMT220 series, resistance temperature sensor

These units will accept input from any 2, 3 or 4 wire resistance temperature sensor.

Third wire compensation is standard to overcome lead resistance variation.

Normal minimum span 10 ohms, lower ranges available to special order.

Differential operation may be specified using 2 X 2 wire sensors.

Open circuit response is normally upscale but may be specified downscale.

Input and third wire drives are constant current, for improved linearity.

Output proportional to resistance, or temperature when option 'G' is specified.

Models available

INPUT	Single output	Double output	Transmitter single trip	Transmitter double trip	Double channel
Single	AMT220	AMT221	AMT222	AMT226	AMT228
Differential	AMT223	AMT224	AMT225	AMT227	AMT229

INPUT WIRING

Single channel

Single Differential

TB1 TB1

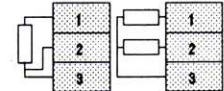

Double channel

TB1 TB1

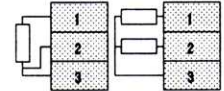

TB2 TB2

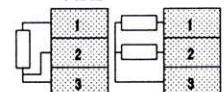

For output and supply wiring, please turn to page 10.

Transmitters

AMT230 series, process

These units will accept input from any standard DC voltage or current source.

On voltage units, input impedance is 1Mohm.

On current units, the input shunt resistor absorbs a maximum of 400mV, allowing many units to be used in series, even on a modest loop.

Input currents from 0-100uA to 0-100mA or voltages from 0-400mV to 0-200V may be used and any input may carry a 20% offset

The range includes the AMT239 deviation transmitter. This gives an output of 0% when both inputs are equal, rising to 100% at maximum deviation.

Models available

INPUT	Single output	Double output	Transmitter single trip	Transmitter double trip	Double channel
Single	AMT230	AMT231	AMT232	AMT233	AMT238
Deviation	AMT239				

INPUT WIRING

Single channel

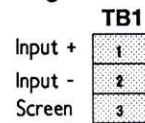

Deviation

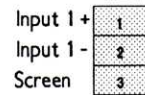

TB2

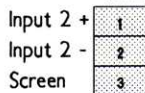

For output and supply wiring, please turn to page 10.

AMT240 series, slidewire or potentiometer

These units will accept input from any 2 or 3 wire slidewire or potentiometer.

Third wire compensation is standard to overcome lead resistance variation.

Normal minimum span 100 ohms, lower ranges available to special order.

Differential operation may be specified using 2 X 2 wire sensors.

Open circuit response is normally upscale but may be specified downscale.

Input and third wire drives are constant current, for improved linearity.

Output proportional to resistance.

Models available

INPUT	Single output	Double output	Transmitter single trip	Transmitter double trip	Double channel
Single	AMT240	AMT241	AMT242	AMT246	AMT248
Differential	AMT243	AMT244	AMT245	AMT247	AMT249

INPUT WIRING

Single channel

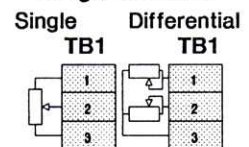

Double channel

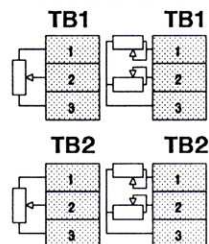

For output and supply wiring, please turn to page 10.

Transmitters

AMT250 series, AC voltage or current

These units will respond to the amplitude of an AC voltage or current input.

No external transformers are required when monitoring mains supplies. Voltages between 150V and 600V or currents between 1A and 10A are isolated and converted by appropriate transformers mounted on the back plate.

Models available

INPUT	Single output	Double output	Transmitter single trip	Transmitter double trip	Double channel
Current	AMT250	AMT251	AMT252	AMT256	AMT258
Voltage	AMT253	AMT254	AMT255	AMT257	AMT259

INPUT WIRING

Single channel

TB1

Input	1
Input	2
Screen	3

Double channel

TB1

Input 1	1
Input 1	2
Screen	3

TB2

Input 2	1
Input 2	2
Screen	3

For output and supply wiring, please turn to page 10.

AMT270 series, strainguage

The 270 series will accept input from - and supply excitation to - devices such as strain-gauges or solid state devices using straingauges to monitor pressure, level, flow etc.

Normal minimum input span is 4mV but lower ranges may be specified to special order.

Unit has the facility of very large zero elevations to give a TARE effect in weighing applications. This elevation may be up to $\pm 400\%$ of span.

Excitation voltage may be adjusted from 3V to 24V and will supply up to 20mA at a regulation of 0.1%. When higher excitation current is required, a range of separately mounted power supplies are available which will supply up to 1A.

Models available

Single output	Double output	Transmitter single trip
AMT270	AMT271	AMT272

INPUT WIRING

TB1

Input +	1
Input -	2
Screen	3

TB2

Excitation +	1
Excitation -	2
Screen	3

For output and supply wiring, please turn to page 10.

AMT280 series, pulse

These units will respond to the frequency of any regular repetitive waveform.

Any waveform may be used, provided the positive peak level exceeds the threshold level.

The threshold is adjustable over a wide range to assist in suppressing input noise.

Any input frequency between 0-25Hz and 0-25kHz may be specified.

Input level may be anywhere between 50mV and 30V p-p.

Response time is determined by input frequency. Typically it is less than 500mSec but when the maximum input frequency is under 1kHz, it is proportionately increased.

Models available

Single output	Double output	Transmitter single trip	Transmitter double trip
AMT280	AMT281	AMT282	AMT286

INPUT WIRING

TB1

Input +	1
Input -	2
Screen	3

For output and supply wiring, please turn to page 10.

Two-wire transmitters

ATW510 series, thermocouple and millivolt

These units will accept input from any BS4937 and ISA B,E,J,K,S,R,T or Pallaplat thermocouple, or millivolt source.

Thermocouple input units have automatic cold junction compensation.

Normal minimum span 4mV, lower ranges available to special order.

Source resistance up to 1000ohms for specified performance.

Open circuit response may be specified as upscale or downscale.

Input impedance 1Mohm, shunted by burnout drive.

Models available

INPUT	Standard mount	IP65 mount
Thermocouple	ATW511	ATW512
Millivolts	ATW516	ATW517

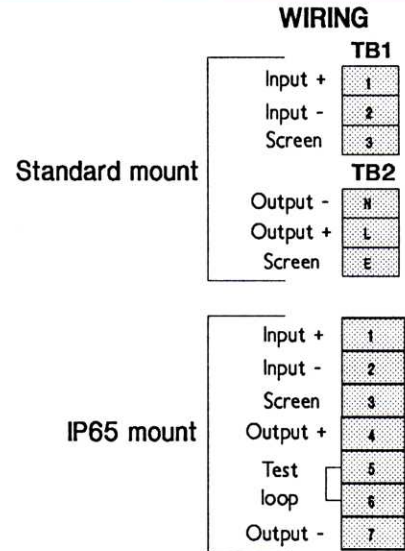

ATW520 series, resistance temperature sensor

These units will accept input from any 2, 3 or 4 wire resistance temperature sensor.

Third wire compensation is standard to overcome lead resistance variation.

Normal minimum span 10 ohms, lower ranges available to special order.

Open circuit response is normally upscale but may be specified downscale.

Input and third wire drives are constant current, for improved linearity.

Models available

Standard mount	IP65 mount
ATW521	ATW522

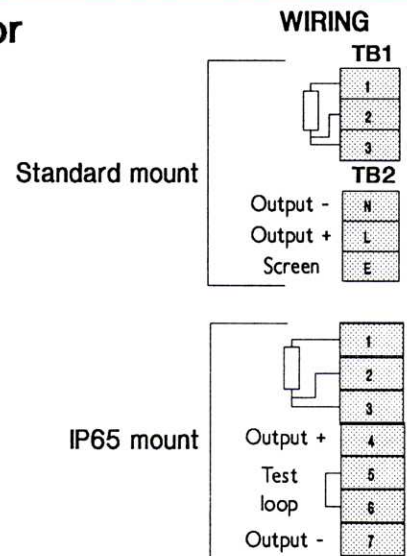

ATW530 series, process

These units will accept input from any standard DC voltage or current source.

On voltage units, input impedance is 1Mohm.

On current input units, the shunt resistor absorbs a maximum of 400mV allowing many units to be used in series, even on a modest loop.

Input currents from 0-100uA to 0-100mA or voltages from 0-400mV to 0-200V may be used and any input may carry a 20% offset.

Models available

Standard mount	IP65 mount
ATW531	ATW532

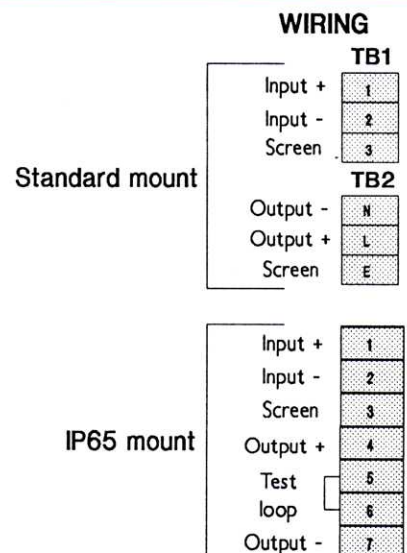

Two-wire transmitters & PSUs

ATW540 series, slidewire and potentiometer

These will accept input from any 2 or 3 wire slidewire or potentiometer. Third wire compensation is standard to overcome lead resistance variation. Normal minimum span 100 ohms, lower ranges available to special order. Open circuit response is normally upscale but may be specified downscale. Input and third wire drives are constant current, for improved linearity.

Models available

Standard mount	IP65 mount
ATW541	ATW542

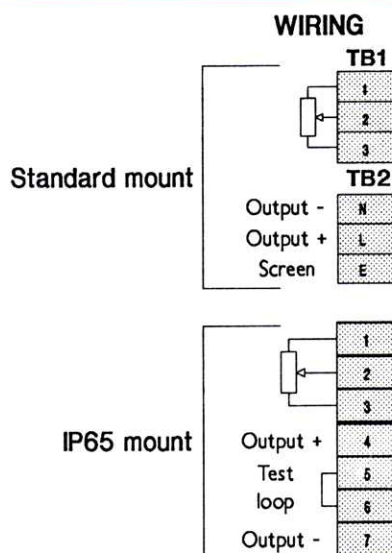

APS901 series, power supplies

These units are available as single or double channel. When double channel is specified, the two channels are totally isolated. Each channel will operate in constant current or constant voltage mode. Outputs are adjustable over the range 1-25V at up to 25mA: Normally by blindset potentiometer but optionally by single or ten turn calibrated dials. A prolonged output short circuit will cause no damage to the unit. Load variation, <0.2%. Supply variation, <0.1%.

Models available

Single channel	Double channel
APS901/1	APS901/2

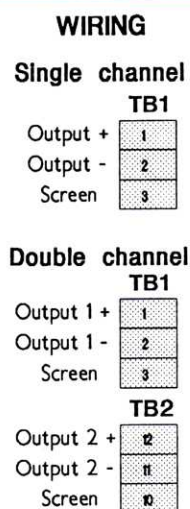

Other power supplies

When greater output current is required, to operate multiple units for instance, a range of other power supplies are also available from Amelec.

Types available include 12V, 24V and 48V, at output currents of 0.25A, 0.5A and 1A, with output regulation to suit the required application.

Mounting type and size will depend on the actual power requirements but most units are available in single or double width 'A' series enclosures.

Please contact our Technical Sales Department with your specific requirements.

Options

Option 'DI', digital display

This is a 3½ digit indicator which is available in 8mm red or green LED or 12mm LCD. It will display any level from -1999 to +1999 and has its own internal gain and offset controls allowing, for instance, full scale indication over a small portion of actual input span.

When this option is specified, the calibrated trip dials are replaced with blindset potentiometers and 'READ' pushbuttons for each trip point.

Under normal conditions, the display will indicate the input to the unit, either as a percentage of total input or in engineering units. When a pushbutton is pressed, the display will indicate that tripset level, in the same units, allowing very accurate adjustment.

Available with most of the options listed below.

Option 'M', power supply

This is very similar to the APS901/1 described on page 7 but is mounted internally. When fitted, it allows a standard unit to provide power to an external device, such as a strain gauge, input pre-amplifier or a 2-wire transmitter.

The output is adjustable over the range 2-25V at any current up to 25mA by an internal potentiometer which may, optionally, be fitted to the front panel. Load variation is better than 10mV over the full current range.

Depending on application, the output of this power supply may be wired to terminal block 2 or to unused terminals on terminal block 3. When used to power a 2-wire transmitter, the power supply output is wired internally on the unit in series with the current sensing shunt resistor, allowing full 2-wire operation.

Available with most of the options listed below.

Other options

Suffix	Description
/B	Remote tripset potentiometers
/C	Ten turn tripset potentiometers with calibrated dials.
/DA★	Analogue indication of input or output level.
/J★	Input test injection jack.
/K★	RFI protection to BS6667 Part 3.
/L	Latched relay - normally reset by pushbutton on front panel.
/P★	Calibration test point.
/S	Sealed relay.
/T	Timed relay - optionally with timer control mounted on the front panel.
/V	Variable deadband (1-20% of span).

Some combinations of options are physically incompatible. If in doubt, please contact our Technical Sales. Those options marked with an asterisk are also suitable for 2-wire transmitters.

Mounting and wiring

IP65 mounting (2-wire only)

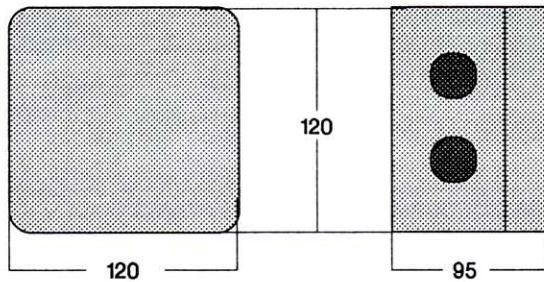

This mounting is available in fibre filled plastic; or diecast aluminium when RFI protection is required. Fixing holes should be drilled on 102mm by 92mm centres.

Access to the fixing screws is obtained by removal of the enclosure lid, although they do not intrude into the actual interior. Two tapped holes are provided which will accept 20mm conduit fittings. When correctly fitted, this will allow pressurised air purged operation.

WIRING

Input, output and supply connections are made via leaf type terminal blocks which are mounted on the front of single end access enclosures and at the rear on all other 'A' series types. These terminal blocks will accept cables up to 2.5mm². The IP65 enclosure uses a barrier strip which accepts 4mm spades or eyelets.

On most enclosures, other than panel mount, the terminals are separated into two groups by an earthed barrier which is part of the terminal mounting plate.

This barrier, together with the 'U' section terminal cover, ensures that input cables must enter from the top of the unit and supply/output cables from below. This helps meet the requirements of 'N' protection for intrinsically safe installations.

Input wiring

This is given in the individual specification sheets for the various instrument types.

Input access

This is almost invariably from the left, except where shown otherwise. This convention has been followed on input wiring drawings.

Output/relay wiring

The following two drawings show the combinations of outputs available with this range of instruments. The second output and trip connections shown in the first drawing are only available if specified at time of order.

Single output. Double output.
Single output/single trip. Double channel

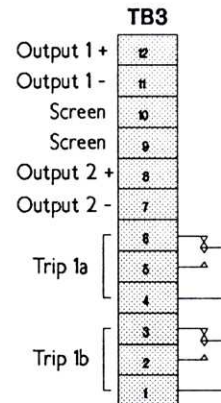

Single output/double trip

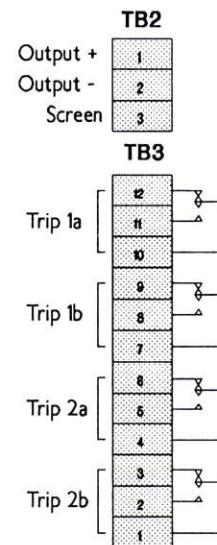

Output access

For panel, single end access or rack mounting units, output wiring access is from the right. For surface mounting units, wiring access is from the left, as shown above.

Supply wiring

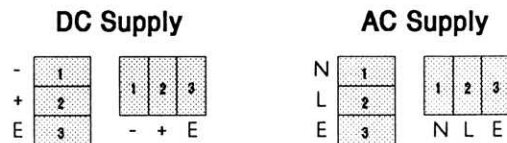

Supply access

For panel, single end access or rack mounting units, output wiring access is from below. For surface mounting units, wiring access is from the left.

Mounting and wiring

All the units in the range are supplied in an Anodised or Achromed extruded aluminium enclosure which may be surface or panel mounting, single end access or 7 way 19" rack. Alternatively, some 2-wire transmitters are supplied in a diecast or plastic IP65 enclosure.

When a unit is fitted into an enclosure, the edge connector at the rear of the main printed circuit board mates with a socket which is wired to the terminal blocks. The unit is retained in the enclosure by two M3 screws which pass through countersunk holes in the front panel and into tapped holes at the front of the enclosure.

The 'U' channel terminal cover is supplied in two sizes to suit different mounting requirements. For surface mounting units, the 217mm length is supplied and includes the fixing holes. For panel, single end access or rack mounting, the 178mm length is supplied but only when options 'K' or 'EXI' are specified. When supplied, they must be replaced after wiring.

Units may be mounted at any orientation although they would normally be mounted with the front panel vertical. Surface or single end access units should not be mounted closer than 61mm horizontally or 218mm vertically. Panel units should not be mounted closer than 70mm horizontally or 234mm vertically and racks should not be mounted closer than 485mm horizontally or 189mm vertically. All types would normally be mounted further apart than this to ease wiring. At least 180mm must be left at the front of all enclosures to allow for unit withdrawal.

In the following drawings, all dimensions are in mm. Figures in brackets show the added depth of the 'K' enclosures to house the RFI protection components.

Surface mounting

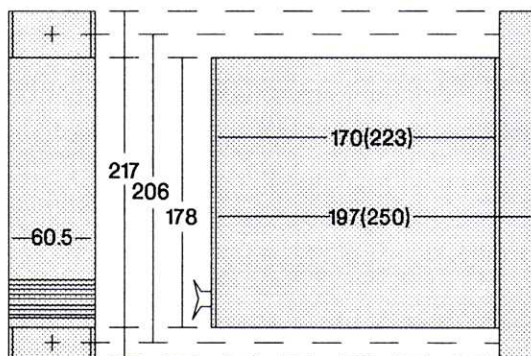

Before wiring, the unit must be withdrawn from the case, which may then be removed from the 'U' channel by undoing the M4 screw at the top rear of the case, hinging the case downwards and unhooking it from the fixed peg at the lower rear of the case. This exposes the terminal blocks for wiring.

Slots are provided in the terminal plate which allow cables to be passed along the 'U' channel, through the slots and into the terminal blocks. After wiring, the enclosure may be reassembled by reversing these instructions.

Panel mounting

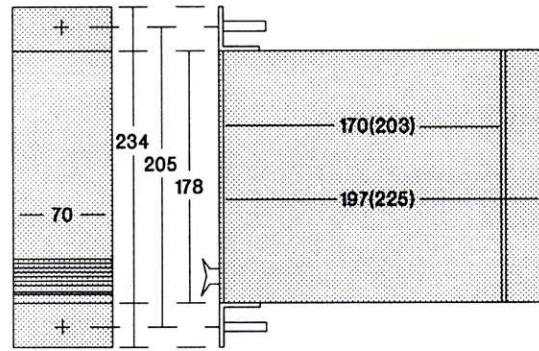

A 65mm wide by 190mm high aperture must be cut in the front panel with 6mm fixing holes above and below. The brackets and front panel are wider than the aperture to obscure any cut edges.

Single end access

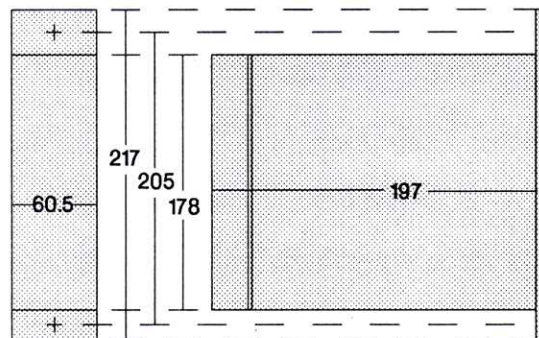

This enclosure is not recommended for use with option 'K'

In this arrangement the terminal blocks are mounted on the front panel, although the enclosure is surface mounted. Since the terminals are on the removable part of the unit, allowance must be made, when wiring, to allow for unit withdrawal without disturbing the wiring to adjacent units or the main loom.

19" Rack mounting

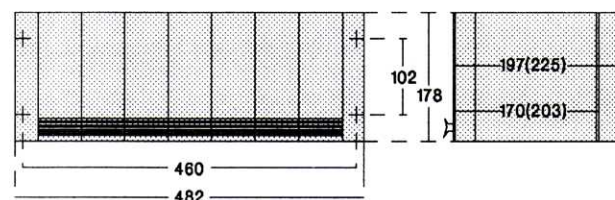

Up to seven units may be mounted in a 19" rack, although other widths may be supplied to suit special requirements.

The rack is normally supplied with fixing brackets to suit panel mounting (as shown above) but may also be supplied for single end access if required.

A 179mm high by 440mm wide aperture must be cut in the panel with fixing holes on 102mm by 460mm centres.

Additional information

Expansion to the range

The 'AH' range is still comparatively recent and is constantly being expanded. If the application you require is not covered in this catalogue, please contact our Technical Sales Department as the product may already be in process of being engineered.

AGS products

Over the years, Amelec have been called upon to solve a wide variety of process control problems. Many of the resultant products have proved so successful they have become part of our standard range. Indeed, some appear in this catalogue as standard products.

Other products, however, are specifically designed to solve a particular problem. These models do not have sufficient demand to become standard products but, since they are manufactured to the same standard, they are kept on file, ready to solve similar problems for subsequent clients.

If you have a process control problem, please ask for our shortform AGS list. Alternatively, contact our Technical Sales Department, giving full details of the problem and they will either recommend an existing AGS product or design one to suit your particular application.

Warranty and service

All Amelec products are guaranteed for ten years against faulty components or manufacture but not against misuse.

To claim under this warranty, equipment should be returned, carriage paid by the customer, to Amelec Instruments, Cochran Close, Crownhill, Milton Keynes, MK8 0AJ, together with details of the fault.

Attempted repairs or component replacement during the warranty period may render the warranty null and void, unless authorised by Amelec.

Amelec will undertake any repairs and will also supply replacement printed circuit board assemblies on an exchange price basis. Please contact the Technical Sales Department for further details.

Where the reported fault is a site problem, Amelec will make their own technical staff available to offer assistance. This service will be charged to the customer at the rate currently in force.

Ordering

When ordering, please give the following details:-

1. Model number
2. Supply voltage and frequency
3. Mounting - Surface, Panel, Single end access or Rack
4. Input span, output span, offset and source
5. Open circuit response - If not specified, default is upscale for thermocouple, millivolt and resistance input units, downscale for process
6. Relay status and mode - If not specified, default is normally energised and single trips are set to Hi, double trips to Hi/Lo. LEDs are lit when relays are energised
7. Any options required
8. Information appropriate to any options ordered

A complete range of Trip amplifiers, Signal conditioners and Arithmetic units are also available in these complementary ranges:-

A 4U X 12E Surface, Panel, SEA and Rack **AB** 3U X 7E Rack. **AD** DIN rail and Surface. **AH** 3U X 4E Rack

Please ask for our other catalogues

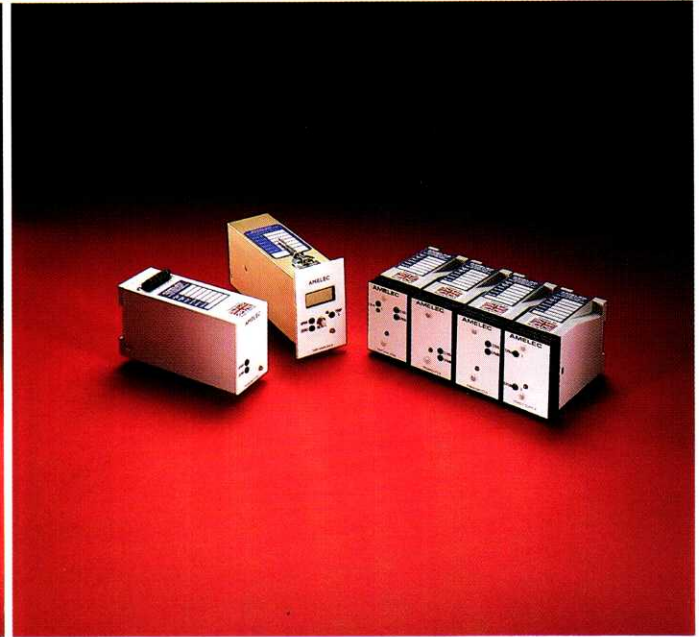
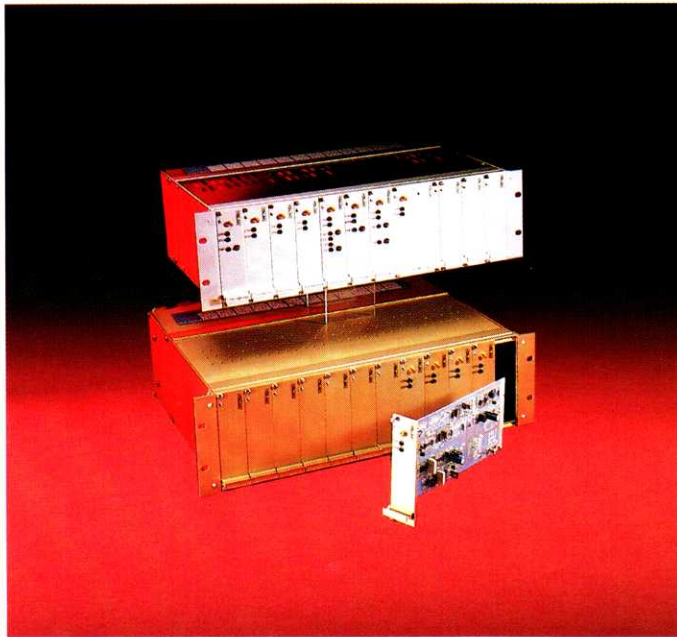

Cochran Close Crownhill Milton Keynes MK8 0AJ

www.amelec-uk.com Tel: 01908 567003 Fax: 01908 566735 sales@amelec-uk.com