

AMELEC

Signal  Conditioning

INDUSTRY STANDARD 'AB' RANGE SIGNAL TRANSMITTERS, TRIP AMPLIFIERS, ARITHMETIC UNITS

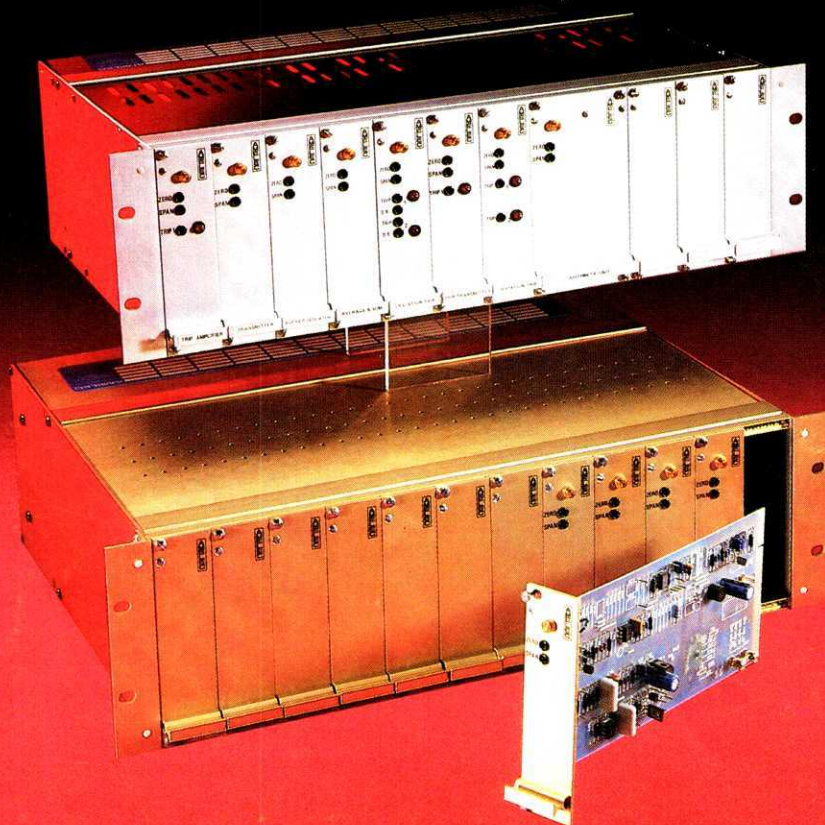

- Suitable for input from thermocouple, millivolt, RTD, slide wire or process signals.
- Transmitters available for single or double output, some with trip. Trip amplifiers for single or double channel, each with single or double trip.
- Trip points set by multiturn potentiometer. These, and other major controls, are accessible through the front panel. Other controls internally accessible.
- Supply voltages of 120VAC, 240VAC, or 24VDC available at no additional cost. All units individually fused and front panel supply indicators fitted.
- Digital indication of input and trip points may be specified, scaled as a percentage of input span or in engineering units. Usually mounted separately in the rack.
- RFI protection to BS6667, Part 3 available for all units.
- Manufactured and tested to BS5750, Part 2.
- AMELEC standard 10 year guarantee.

Specification

INPUT DATA

Input source

For details see individual specification

Open circuit response

For details see individual specification.

Input Impedance (Voltage input)

>1Mohm at amplifier input. This will be shunted by burnout drive or input conditioning components.

SUPPLY DATA

Power supplies

AC models	115VAC \pm 20% 230VAC \pm 20%
DC models	24VDC \pm 2.5V
2 wire	12 - 60VDC

Consumption

Single transmitter	3VA
Trip amplifier	3VA
Transmitter/trip	5VA
2 Wire transmitter	250mW

OUTPUT DATA

Output signals

Standard units

Any constant current from 0-100uA to 0-20mA (at up to 20V loop) or any constant voltage from 0-1V to 0-10V (at up to 20mA loading).

2-wire units

4-20mA or 10-50mA as modulation of supply voltage.

Response time

<400mSec. Unless otherwise stated.

Relay specification

DP/DT or SP/DT for each trip, unless otherwise stated. Contacts are rated at 250VAC, 2A, 100VA (Resistive).

Relay function

Selected by PC link. Default is normally energised, relay to de-energise on trip (fail safe operation).

Relay status

Indicated by a red LED for each trip, mounted on the front panel. Lit when relay is energised.

Controls

ZERO	\pm 25%
SPAN	\pm 50%
TRIP (When fitted)	0-100%
DEADBAND (When fitted)	1-20%

CONDITIONS

Ambient temperature

Working	-20°C to +60°C
Storage	-40°C to +70°C

Humidity

From 5% to 95% R.H.

Vibration

1g at 15Hz to 150Hz.

ELECTRICAL STANDARDS

Insulation Input-output-contacts-earth-channel

1000V RMS continuous. 2000V for 20uSec. Derate to 500VDC for option 'K' enclosures.

Fusing

Power supply fused. Spare fuse mounted on PCB.

WIRING AND MOUNTING

Terminals

For conductors up to 2.5mm².

Weight

<1kg per module.

Position

Any position is acceptable.

Mounting

Standard units have a 3U by 7E front panel and up to 12 of these may be mounted in a 19" rack. Some units are double width and a 19" rack will accept up to 6 of these. Both types may be freely intermixed.

Additional protection

Enclosures are available to NEMA 12 oiltight, NEMA 4 watertight and IP54 for N-protection.

PERFORMANCE

Input/output linearity

<0.1% error, unless otherwise stated.

Series mode rejection

<0.1% error for 50Hz input at 5% of span amplitude.

Common mode rejection

<0.1% error for 250V RMS.

Temperature effect on zero

<0.02% per °C.

Temperature effect on span

<0.01% of span per °C or <0.1°C per °C, whichever is the greater.

Temperature effect on suppression/elevation

<0.02% of suppression/elevation per °C.

Supply voltage effect

<0.01% per % input change.

Trip adjustment

Infinitely variable by multiturn potentiometers, which are accessible through the front panel.

Deadband

Standard 1%. Also available adjustable from 1 to 20% by multiturn potentiometer.

RFI rejection

Standard units have some RFI rejection due to their design and construction. However, for extra protection to BS6667, specify option 'K'.

Permissible input overload

mV input	20V
DC voltage input	200V
DC current input	500%
AC voltage input	200%
AC current input	500%
Resistance input	6V

Trip amplifiers

ABT610 series, thermocouple and millivolt

These units will accept input from any BS4937 and ISA B,E,J,K,S,R,T or Pallaplat thermocouple, or millivolt source.

Thermocouple input units have automatic cold junction compensation.

Normal minimum span 4mV, lower ranges available to special order.

Source resistance up to 1000ohms for specified performance.

Open circuit response may be specified as upscale or downscale.

Input impedance 1Mohm, shunted by burnout drive.

Models available

INPUT	Single channel		Double channel	
	Single trip	Double trip	Single trips	Double trips
Thermocouple	ABT611	ABT612	ABT613	-
Millivolts	ABT615	ABT616	ABT617	ABT619

INPUT WIRING

Single channel

Input +	1
Input -	2
Screen	3

Double channel

Input 1 +	1
Input 1 -	2
Screen	3
Input 2 +	4
Input 2 -	5
Screen	6

For output and supply wiring please turn to page 14.

ABT620 series, resistance temperature sensor

These units will accept input from any 2, 3 or 4 wire resistance temperature sensor.

Third wire compensation is standard to overcome lead resistance variation.

Normal minimum span 10 ohms, lower ranges available to special order.

Open circuit response is normally upscale but may be specified downscale.

Input and third wire drives are constant current, for improved linearity.

Differential operation may be specified, using 2 x 2 wire sensors.

Models available

INPUT	Single channel		Double channel	
	Single trip	Double trip	Single trips	Double trips
Single	ABT621	ABT622	ABT623	-
Differential	ABT625	ABT626	ABT627	-

INPUT WIRING

Single channel

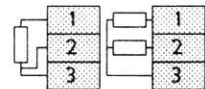

Single Differential

Double channel

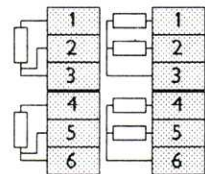

For output and supply wiring please turn to page 14.

ABT630 series, process

These units will accept input from any standard DC voltage or current source.

On voltage units, input impedance is 1Mohm.

On current input units, the shunt resistor absorbs a maximum of 400mV allowing many units to be used in series, even on a modest loop.

Input currents from 0-100uA to 0-100mA or voltages from 0-400mV to 0-200V may be used and any input may carry a 20% offset

Models available

Single channel		Double channel	
Single trip	Double trip	Single trips	Double trips
ABT631	ABT632	ABT633	ABT638

INPUT WIRING

Single channel

Input +	1
Input -	2
Screen	3

Double channel

Input 1 +	1
Input 1 -	2
Screen	3
Input 2 +	4
Input 2 -	5
Screen	6

For output and supply wiring please turn to page 14.

Trip amplifiers

ABT639, process input deviation trip

This unit will compare two inputs which need not necessarily be of the same type but do share a common 0V.

The upper trip will change state when Input 1 exceeds Input 2 by more than the level set on the upper potentiometer. The lower trip will change state when Input 2 exceeds Input 1 by more than the level set on the lower potentiometer. Potentiometers represent 0-50% of span.

Adjustable deadband may also be fitted, controlled by blindset potentiometers, to accurately control the point at which the trip relays return to normal. Deadband potentiometers represent 1-20% of span.

INPUT WIRING

Input 1 +	1
Input 1 -	2
Screen	3
Input 2 +	4
Input 2 -	5
Screen	6

For output and supply wiring, please turn to page 14.

ABT640 series, slidewire and potentiometer

These will accept input from any 2 or 3 wire slidewire or potentiometer. Third wire compensation is standard to overcome lead resistance variation. Normal minimum span 100 ohms, lower ranges available to special order. Open circuit response is normally upscale but may be specified downscale. Input and third wire drives are constant current, for improved linearity. Differential operation may be specified, using 2 x 2 wire sensors.

Models available

INPUT	Single channel		Double channel	
	Single trip	Double trip	Single trips	Double trips
Single	ABT641	ABT642	ABT643	-
Differential	ABT645	ABT646	ABT647	-

INPUT WIRING

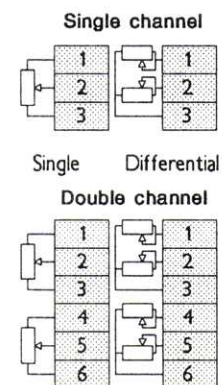

For output and supply wiring please turn to page 14.

ABT650 series, AC voltage or current

These units will respond to the amplitude of an AC voltage or current input.

No external transformers are required when monitoring mains supplies. Voltages between 150V and 600V or currents between 1A and 10A are isolated and converted by appropriate transformers, which are mounted adjacent to the rack.

Models available

INPUT	Single trip	Double trip
Current	ABT651a	ABT651b
Voltage	ABT652a	ABT652b

INPUT WIRING

Input	1
Input	2
Screen	3

For output and supply wiring, please turn to page 14.

Transmitters

ABM710 series, thermocouple and millivolt

These units will accept input from any BS4937 and ISA B,E,J,K,S,R,T or Pallaplat thermocouple, or millivolt source.

Thermocouple input units have automatic cold junction compensation.

Normal minimum span 4mV, lower ranges available to special order.

Source resistance up to 1000ohms for specified performance.

Open circuit response may be specified as upscale or downscale.

Input impedance 1Mohm, shunted by burnout drive.

Models available

INPUT	Single output	Double output	Transmitter/ single trip
Thermocouple	ABM710	ABM711	ABM712
Millivolts	ABM713	ABM714	ABM715

INPUT WIRING

Input +	1
Input -	2
Screen	3

For output and supply wiring please turn to page 14.

ABM720 series, resistance temperature sensor

These units will accept input from any 2, 3 or 4 wire resistance temperature sensor.

Third wire compensation is standard to overcome lead resistance variation.

Normal minimum span 10 ohms, lower ranges available to special order.

Open circuit response is normally upscale but may be specified downscale.

Input and third wire drives are constant current, for improved linearity.

Differential operation may be specified, using 2 x 2 wire sensors.

Models available

INPUT	Single output	Double output	Transmitter/ single trip
Single	ABM720	ABM721	ABM722
Differential	ABM723	ABM724	ABM725

INPUT WIRING

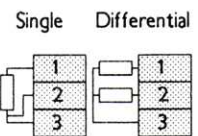

For output and supply wiring please turn to page 14.

ABM730 series, process

These units will accept input from any standard DC voltage or current source

On current input units, the shunt resistor absorbs a maximum of 400mV allowing many units to be used in series, even on a modest loop.

Input currents from 0-100uA to 0-100mA or voltages from 0-400mV to 0-200V may be used and any input may carry a 20% offset

This range includes the ABM739 deviation transmitter. This gives an output of 0% when both inputs are equal, rising to 100% at maximum deviation.

Models available

INPUT	Single output	Double output	Transmitter/ single trip
Single	ABM730	ABM731	ABM732
Deviation	ABM739		

INPUT WIRING

Single input

Input +	1
Input -	2
Screen	3

Deviation input

Input 1 +	1
Input 1 -	2
Screen	3
Input 2 +	4
Input 2 -	5
Screen	6

For output and supply wiring please turn to page 14.

Transmitters

ABM740 series, slidewire and potentiometer

These will accept input from any 2 or 3 wire slidewire or potentiometer. Third wire compensation is standard to overcome lead resistance variation. Normal minimum span 100 ohms, lower ranges available to special order. Open circuit response is normally upscale but may be specified downscale. Input and third wire drives are constant current, for improved linearity. Differential operation may be specified, using 2 x 2 wire sensors.

Models available

INPUT	Single output	Double output	Transmitter/ single trip
Single	ABM740	ABM741	ABM742
Differential	ABM743	ABM744	ABM745

INPUT WIRING

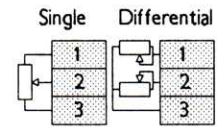

For output and supply wiring please turn to page 14.

ABM750 series, AC voltage or current

These units will respond to the amplitude of an AC voltage or current input.

No external transformers are required when monitoring mains supplies. Voltages between 150V and 600V or currents between 1A and 10A are isolated and converted by appropriate transformers, which are mounted adjacent to the rack.

Models available

INPUT	Single output	Double output	Transmitter/ single trip
Current	ABM750	ABM751	ABM752
Voltage	ABM753	ABM754	ABM755

INPUT WIRING

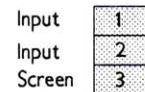

For output and supply wiring, please turn to page 14.

ABM770, strainguage

This unit will accept input from - and supply excitation to - devices such as strain-gauges or solid state devices using strainguages to monitor pressure, level, flow etc.

Normal minimum input span is 4mV but lower ranges may be specified to special order.

Unit has the facility of very large zero elevations to give a TARE effect in weighing applications. This elevation may be up to $\pm 400\%$ of span.

Excitation voltage may be adjusted from 3V to 24V and will supply up to 20mA at a regulation of 0.1%. When higher excitation current is required, a range of separately mounted power supplies are available which will supply up to 1A.

INPUT WIRING

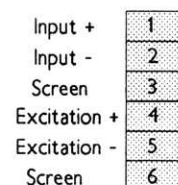

For output and supply wiring, please turn to page 14.

Two-wire transmitters

ABW510 series, thermocouple and millivolt

These units will accept input from any BS4937 and ISA B,E,J,K,S,R,T or Pallaplat thermocouple, or millivolt source.

Thermocouple input units have automatic cold junction compensation.

Normal minimum span 4mV, lower ranges available to special order.

Source resistance up to 1000ohms for specified performance.

Open circuit response may be specified as upscale or downscale.

Input impedance 1Mohm, shunted by burnout drive.

Models available

INPUT	Standard access	Single end access
Thermocouple	ABW511	ABW512
Millivolts	ABW516	ABW517

WIRING

Standard wiring

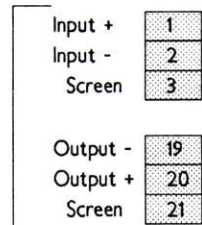

Single end access

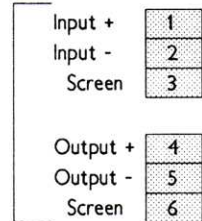

ABW520 series, resistance temperature sensor

These units will accept input from any 2, 3 or 4 wire resistance temperature sensor.

Third wire compensation is standard to overcome lead resistance variation.

Normal minimum span 10 ohms, lower ranges available to special order.

Open circuit response is upscale.

Input and third wire drives are constant current, for improved linearity.

Models available

Standard access	Single end access
ABW521	ABW522

WIRING

Standard wiring

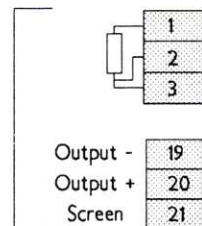

Single end access

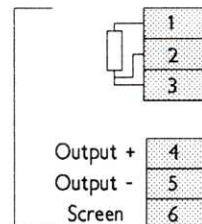

ABW530 series, process

These units will accept input from any standard DC voltage or current source.

On voltage units, input impedance is 1Mohm.

On current input units, the shunt resistor absorbs a maximum of 400mV allowing many units to be used in series, even on a modest loop.

Input currents from 0-100uA to 0-100mA or voltages from 0-400mV to 0-200V may be used and any input may carry a 20% offset.

Models available

Standard access	Single end access
ABW531	ABW532

WIRING

Standard wiring

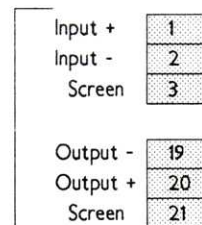

Single end access

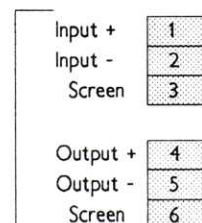

Two-wire transmitters & PSUs

ABW540 series, slidewire and potentiometer

This will accept input from any 2 or 3 wire slidewire or potentiometer. Third wire compensation is standard to overcome lead resistance variation. Normal minimum span 100 ohms, lower ranges available to special order. Open circuit response is normally upscale but may be specified downscale. Input and third wire drives are constant current, for improved linearity.

Models available

Standard access	Single end access
ABW541	ABW542

WIRING

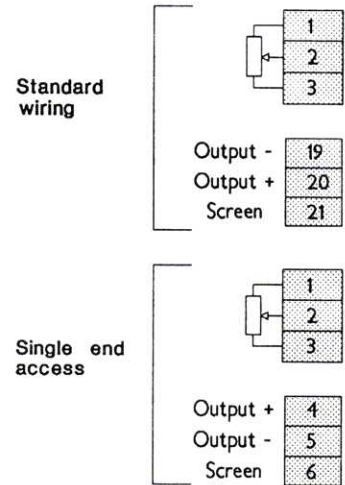

ABP901 series, power supplies

These units are available as single or double channel. When double channel is specified, the two channels are totally isolated. Outputs are adjustable over the range 1-25V at up to 25mA: Normally by blindset potentiometer but optionally mounted to the front panel. A prolonged output short circuit will cause no damage to the unit. Load variation, <0.2%. Supply variation, <0.1%.

Models available

Single channel	Double channel
ABP901/1	ABP901/2

WIRING

Single channel

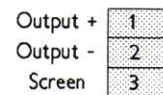

Double channel

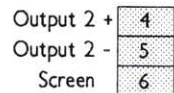
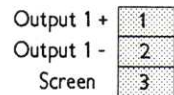

Other power supplies

When greater output current is required, to operate multiple units for instance, a range of other power supplies are also available from Amelec.

Types available include 12V, 24V and 48V, at output currents of 0.25A, 0.5A and 1A, with output regulation to suit the required application.

Mounting type and size will depend on the actual power requirements but most units are available in double, width 'AB' series modules.

Please contact our Technical Sales Department with your specific requirements.

ABC811, scale and bias transmitter

Models may be specified for input from thermocouple, millivolt, RTD, slidewire or process source.

When RTD or slidewire input is specified, third wire compensation is standard to reduce the effect of lead resistance. Thermocouple units have automatic cold junction compensation.

The output span may represent any portion of the input span, with control of offset and gain being by multiturn potentiometers, accessible through the front panel.

Output may follow input (rising input = rising output) or have a reversed characteristic (rising input = falling output).

Many other combinations are possible since the unit is designed to be customised to suit individual applications. Please consult our Technical Sales Department for further details.

ABC812, square root extractor

This unit is designed to operate with any standard process voltage or current source.

It regards both input and output span - which need not necessarily be the same - as 0-1 and will convert 0.01 - 1 (1-100%) of input span to 0.1 - 1 (10-100%) of output span, using a square root law.

Since output accuracy is not specified below 1% input (10% output) a zero cut-off is fitted which will operate when the input moves into this region. It is normally preset to 0.5% and, while the input is between 0% and this level, the output will remain at 0%.

ACCURACY: <0.25% while input remains between 1% and 100%
 LINEARITY: <0.25% while input remains between 1% and 100%.
 RESPONSE TIME: <1Sec for the output to settle within tolerance after an input step change from 5% to 95%.

ABC813, high/low selector

INPUT/OUTPUT WIRING

This will accept up to five process voltage or current sources, which need not necessarily be of the same type but do share a common 0V.

The output span may be configured to be proportional to either the highest or lowest of these inputs; selection being by on-board link.

Input and output wiring is shown to the right. For supply wiring, please see page 14.

Input 1 +	1
Input 1 -	2
Screen	3
Input 2 +	4
Input 2 -	5
Screen	6
Output +	7
Output -	8
Screen	9
Input 3 +	10
Input 3 -	11
Screen	12
Input 4 +	13
Input 4 -	14
Screen	15
Input 5 +	16
Input 5 -	17
Screen	18

Arithmetic units

ABC814, averager/adder/subtractor

INPUT/OUTPUT WIRING

These units will accept up to five current or voltage inputs, which need not necessarily be of the same type but do share a common 0V. These inputs may carry any sensible weighting, to suit specific requirements.

The unit may be configured to perform a wide variety of addition and subtraction functions and these are best explained with typical examples:-

$$(a) \quad O/P = \frac{I/P1 + I/P2 + I/P3}{3} \quad (b) \quad O/P = \frac{I/P2}{2} + \frac{I/P3}{3} + (5 \times I/P4) - I/P1$$

$$(c) \quad O/P = (.3 \times I/P1) + (.2 \times I/P2) + (.6 \times I/P3) - (.5 \times I/P4) - (.01 \times I/P5)$$

$$(d) \quad O/P = \frac{I/P2}{2} + \frac{I/P4}{4} + 0.5$$

Many other combinations are possible since the unit is designed to be customised to suit individual applications. Please consult our Technical Sales Department for details.

Input and output wiring is shown to the right. For supply wiring, please see page 14.

Input 1 +	1
Input 1 -	2
Screen	3
Input 2 +	4
Input 2 -	5
Screen	6
Output +	7
Output -	8
Screen	9
Input 3 +	10
Input 3 -	11
Screen	12
Input 4 +	13
Input 4 -	14
Screen	15
Input 5 +	16
Input 5 -	17
Screen	18

ABC815, multiplier/divider

INPUT/OUTPUT WIRING

This will accept up to three standard voltage or current process control signals, which need not necessarily be of the same type but do share a common 0V. To suit specific applications, these inputs may carry any weighting from 10% to 200% or zero offset up to $\pm 300\%$.

Assuming equal weighting, the functions carried out by this unit are as follows:

$$\text{MULTIPLIER} = A \times B. \quad \text{DIVIDER} = \frac{A}{B} \text{ or } \frac{A}{C} \quad \text{MULTIPLIER/DIVIDER} = \frac{A \times B}{C}$$

LINEARITY: Multiply only. <0.2% over 20 : 1 range.
 Divide only <0.5% over 3 : 1 range
 Multiply/divide <1% over 30 : 1 range

Input and output wiring is shown to the right. For supply wiring, please see page 14.

Input A +	1
Input A -	2
Screen	3
Input B +	4
Input B -	5
Screen	6
Output +	7
Output -	8
Screen	9
Input C +	10
Input C -	11
Screen	12
	13
	14
	15
	16
	17
	18

ABC816, high/low limiter

Models may be specified for input from thermocouple, millivolt, RTD, slidewire or process source.

When RTD or slidewire input is specified, third wire compensation is standard to reduce the effect of lead resistance. Thermocouple units have automatic cold junction compensation.

Under normal conditions, the output will follow the input. However, two additional controls are fitted to establish upper and lower limits on the output.

The HIGH limit may be adjusted over the range 40% to 100% and the LOW limit over the range 0% to 60%. Both these controls are blindset potentiometers, accessible through the front panel.

Arithmetic units

ABC819, sample/hold transmitter

INPUT/OUTPUT WIRING

This unit is designed to operate with any standard process voltage or current source.

When the unit is in 'SAMPLE' mode, the output will follow the input with little or no delay but, when put into 'HOLD' mode, the output will remain at the level it was at, when put into this mode, indefinitely. Digital techniques are employed to ensure that the held output will not 'droop', no matter how long the unit is kept in this mode.

'SAMPLE'/'HOLD' control may be by normally open or normally closed contact or by normally high or normally low voltage drive of between 5V and 12V.

Control is effected with a single drive, wired to the 'HOLD' input, with the customer specifying which mode is required for which control condition.

This unit may also be supplied as a peak detector, where the output will follow the input all the while it is rising but will remain at the highest level so far attained if the input falls. When used in this mode, the 'HOLD' input acts as a 'RESET', setting the output to zero.

Input and output wiring is shown to the right. For supply wiring, please see page 14.

Input +	1
Input -	2
Screen	3
HOLD +	4
HOLD -	5
Screen	6
Output +	7
Output -	8
Screen	9
	10
	11
	12
	13
	14
	15
	16
	17
	18

ABC821, lead/lag transmitter

This unit is designed to operate with any standard process voltage or current source.

When operated in 'LAG' mode, the output will follow the input with a limit on the output rate of change. This limit is digitally derived and is extremely linear.

When operated in 'LEAD' mode, if the input undergoes a step change, the output will also make a step change, in the same direction, then ramp to the new output level at the desired rate. The output step change may be set anywhere in the range 10% - 1000%.

Two separate digital ramp generators are included, each adjustable from 1 Sec to 6000 Secs for a 100% output change. It is therefore possible, in both modes, to have different rates of change for rising and falling outputs; allowing, for instance, a very slow increase of current into an actuator but a very rapid decrease in current, should the input to the unit drop.

The ABC821, in 'LAG' mode, replaces the analogue version of this product, the ABC818.

ABC822, lineariser

Models may be specified for input from thermocouple, millivolt, RTD, slidewire or process source.

When RTD or slidewire input is specified, third wire compensation is standard to reduce the effect of lead resistance. Thermocouple units have automatic cold junction compensation.

The unit is, however, most notably used to linearise the output of flow transmitters, radiation pyrometers, etc., by means of an eight break point lineariser. This will give a straight-line approximation to correct the input curve.

The same unit will generate mathematical curves, such as Sine, Cosine, square, square root and many others from a linear input drive.

LINEARITY: Better than a 10 : 1 improvement over input curve.

RESPONSE TIME: <500mSec to respond within tolerance to an input 95% step change.

Arithmetic units

ABC853, linear integrator

INPUT/OUTPUT WIRING

This unit is designed to accept input from any standard voltage or current source.

It will provide continuous integration and totalisation of quantities such as; flow, BTU, watt/hours volt/hours, etc.

Output pulses are 24V, 30mSec and are suitable for driving most electro-mechanical counters. If option 'R' is specified, output is also 30mSec pulses from a set of voltage free contacts. When this option is specified, the unit must be mounted with the front panel vertical.

Output pulse rate is continuously adjustable from 0 - 50 to 0 - 50000 pulses per hour.

To ensure that spurious pulses are not generated at very low input levels, a zero cut-off control is fitted. This may be adjusted from 0 - 2% of input but is normally preset to .5%.

Input and output wiring is shown to the right. For supply wiring, please see page 14.

Input +	1
Input -	2
Screen	3
	4
	5
	6
Output +	7
Output -	8
Screen	9
Option 'R' N/O	10
N/O	11
Screen	12
	13
	14
	15
	16
	17
	18

ABC855, pulse scaler

INPUT/OUTPUT WIRING

This unit will accept input from any sine, square or triangular waveform from 100Hz to 10000Hz, provided the positive peak level exceeds the threshold level.

The pulses are converted to an analogue level, optimised, then used to generate output pulses.

Output pulses are 24V, 30mSec and are suitable for driving most electro-mechanical counters. If option 'R' is specified, output is also 30mSec pulses from a set of voltage free contacts. When this option is specified, the unit must be mounted with the front panel vertical.

Output pulse rate is continuously adjustable from 0 - 50 to 0 - 50000 pulses per hour.

To ensure that spurious pulses are not generated at very low input levels, a zero cut-off control is fitted. This may be adjusted from 0 - 2% of input but is normally preset to .5%.

Input and output wiring is shown to the right. For supply wiring, please see page 14.

Input +	1
Input -	2
Screen	3
	4
	5
	6
Output +	7
Output -	8
Screen	9
Option 'R' N/O	10
N/O	11
Screen	12
	13
	14
	15
	16
	17
	18

Options

Suffix	Description
/B	Remote tripset potentiometers
/DI	Digital indication of input or output level.
/J★	Input test injection jack.
/K★	RFI protection to BS6667 Part 3.
/L	Latched relay - normally reset by pushbutton on front panel.
/M	External excitation
/P★	Calibration test point.
/S	Sealed relay.
/T	Timed relay - optionally with timer control mounted on the front panel.
/V	Variable deadband (1-20% of span).

Some combinations of options are physically incompatible. If in doubt, please contact our Technical Sales. Those options marked with an asterisk are also suitable for 2-wire transmitters.

Mounting and wiring

Units are designed for high density use, the front panel measuring only 3U high by 7E wide. When certain functions are specified, such as double isolated output or digital indication a 14E wide panel is fitted to accommodate the extra electronics. Up to 12 standard or 6 double width units may be fitted in an AMELEC supplied 19" rack and both types are freely mixable.

All the units in the range consist of a printed circuit board, which contains all the circuitry, at the front of which is an anodised or Achromed aluminium front panel which contains two captive fixing screws, a handle and provides access to any customer controls. A double width unit will usually consist of two printed circuit boards

The rear of any printed circuit boards are formed into 37 way edge connectors, which mate with sockets mounted in the rear of the rack. All input, output and supply connections are made via these connectors. Connectors and sockets are polarised to avoid units being fitted into unsuitably wired positions.

Sockets are wired to individual 20 way connector blocks, mounted on the rear plate of panel mounting racks or below the main rack on wall mounting units. Both types of connector block will accept cables up to 2.5mm².

When option 'K' is specified, all the aluminium parts have an Achrome finish. This allows electrical contact between the parts and assists in suppressing RFI. The other protection components are housed in the rear of the rack.

In the following drawing, all dimensions are in mm. Figures in brackets refer to the increased depth of an option 'K' enclosure.

19" Rack mounting

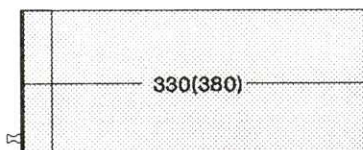
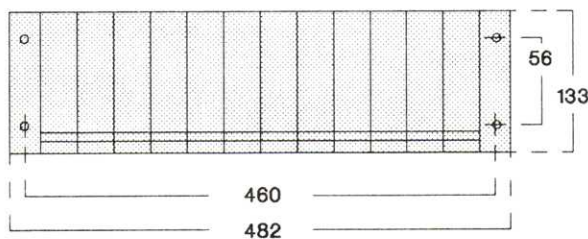

Racks should not be mounted closer together than 485mm horizontally or 135mm vertically. They would normally be mounted further apart than this for ease of wiring. At least 240mm must be left at the front of the rack to allow for module withdrawal.

Front panels

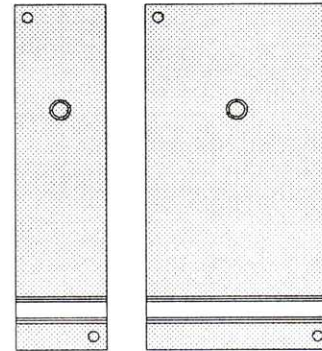

Shown above are typical single and double width panels. The captive fixing screws, supply indicators and handles are shown but other controls are not, since the position of these will vary from module to module.

The front of the handle has a recess to allow for the fitting of an identification or tag label.

Input wiring

In many cases, particularly with multiple input units, input wiring details are given in the individual instrument specification sheets. However, many units are specified for single input from process, millivolt, RTD or thermocouple sources. Details of all types of standard input are given below.

On single width modules, the input is wired to the upper three terminals on the terminal block. On double width modules, it is similarly wired to the right hand terminal block.

Thermocouple, millivolts, process.

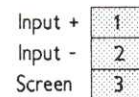

Resistance temperature sensor (RTD)

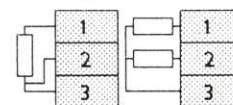

Slidewire or potentiometer

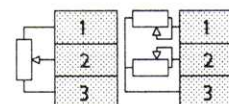

The latter two drawings show the alternative wiring for single and differential input.

Mounting and wiring

All input, output and supply connections are made via 20 way Klippon terminals which are assembled into the rear panel of the rack.

Wiring and terminal screw access is at 90° to the vertical plane. Terminals are of the leaf protection type and will accept cables up to 2.5mm².

Output/relay wiring

Single transmitter, double transmitter, transmitter/single trip

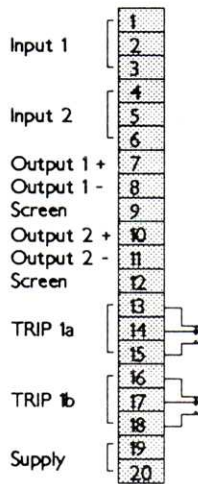

Input 2, output 2 and the trip contacts shown above are specific to particular instruments. They are only present if specified at the time of ordering.

Single channel - single trip

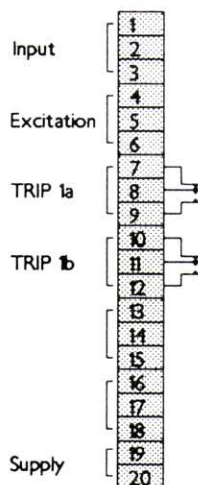

The excitation output is only present when option 'M' is specified at the time of ordering.

Single channel - double trip

Double channel - single trips

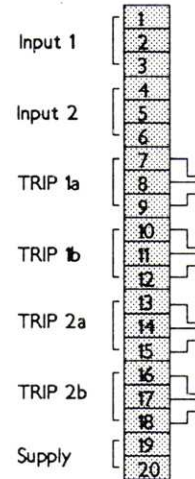

Input 2 is only present on double channel units. On single channel units, these terminals may carry the excitation when option 'M' is specified.

Double channel - double trips

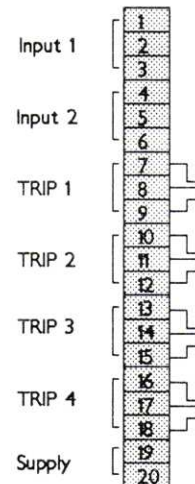

Each set of single pole changeover contacts is operated by it's individual trip circuit.

Supply wiring

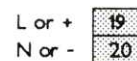

All earth connections are made to a single high integrity earth stud mounted in the centre of the back plate.

A complete range of Trip amplifiers, Signal conditioners and Arithmetic units are also available in these complementary ranges:-

A 4U X 12E Surface, Panel, SEA and Rack **AB** 3U X 7E Rack. **AD** DIN rail and Surface. **AH** 3U X 4E Rack

Please ask for our other catalogues

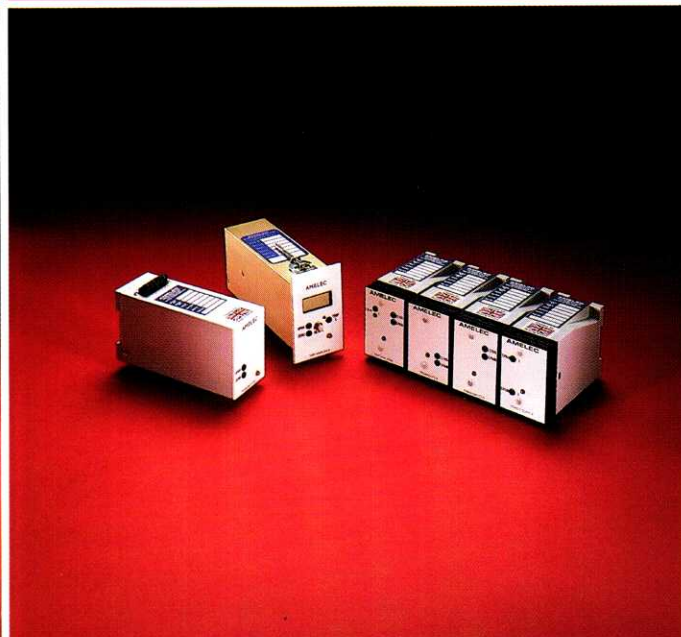
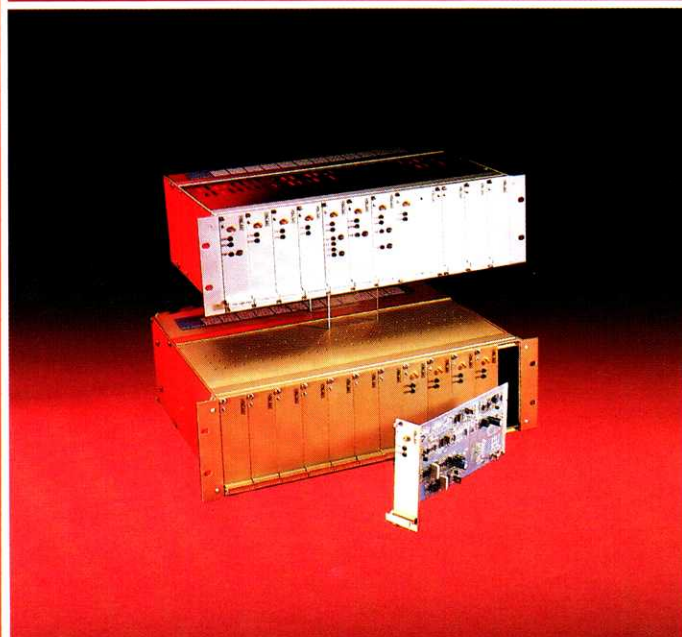
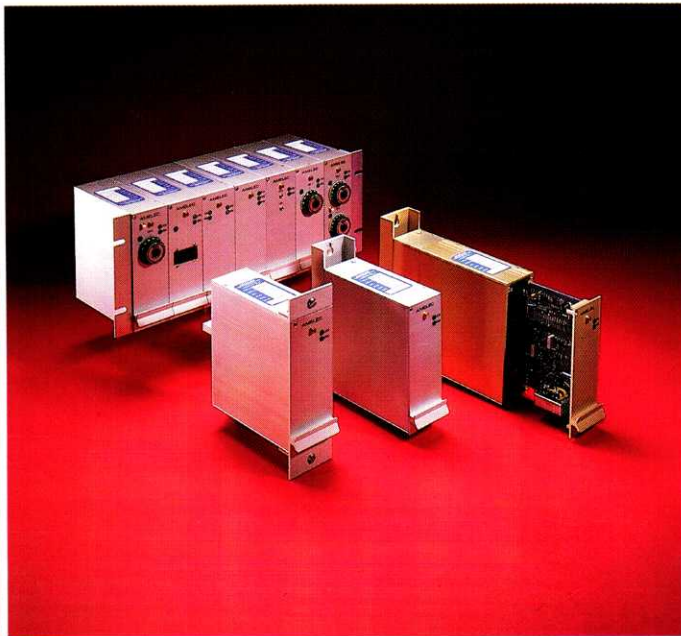
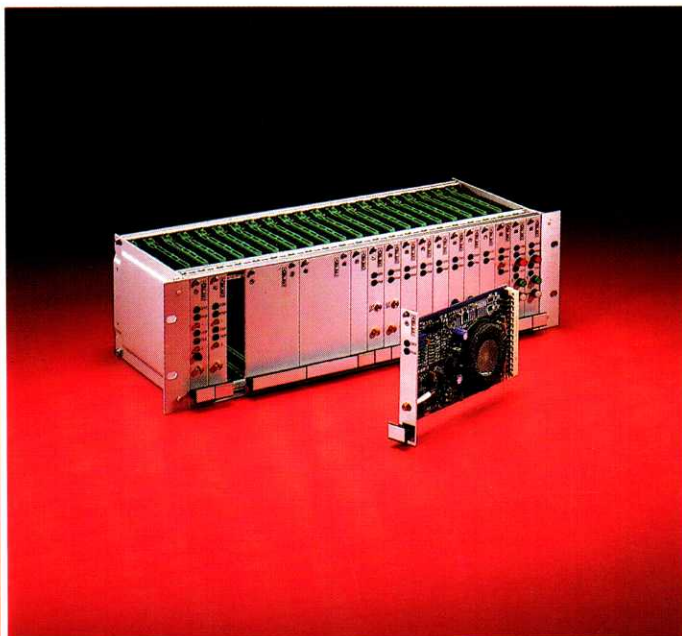

Cochran Close Crownhill Milton Keynes MK8 0AJ

www.amelec-uk.com Tel: 01908 567003 Fax: 01908 566735 sales@amelec-uk.com

Additional information

Expansion to the range

The 'AH' range is still comparatively recent and is constantly being expanded. If the application you require is not covered in this catalogue, please contact our Technical Sales Department as the product may already be in process of being engineered.

AGS products

Over the years, Amelec have been called upon to solve a wide variety of process control problems. Many of the resultant products have proved so successful they have become part of our standard range. Indeed, some appear in this catalogue as standard products.

Other products, however, are specifically designed to solve a particular problem. These models do not have sufficient demand to become standard products but, since they are manufactured to the same standard, they are kept on file, ready to solve similar problems for subsequent clients.

If you have a process control problem, please ask for our shortform AGS list. Alternatively, contact our Technical Sales Department, giving full details of the problem and they will either recommend an existing AGS product or design one to suit your particular application.

Warranty and service

All Amelec products are guaranteed for ten years against faulty components or manufacture but not against misuse.

To claim under this warranty, equipment should be returned, carriage paid by the customer, to Amelec Instruments, Cochran Close, Crownhill, Milton Keynes, MK8 0AJ, together with details of the fault.

Attempted repairs or component replacement during the warranty period may render the warranty null and void, unless authorised by Amelec.

Amelec will undertake any repairs and will also supply replacement printed circuit board assemblies on an exchange price basis. Please contact the Technical Sales Department for further details.

Where the reported fault is a site problem, Amelec will make their own technical staff available to offer assistance. This service will be charged to the customer at the rate currently in force.

Ordering

When ordering, please give the following details:-

1. Model number
2. Supply voltage and frequency
3. Mounting - Surface, Panel, Single end access or Rack
4. Input span, output span, offset and source
5. Open circuit response - If not specified, default is upscale for thermocouple, millivolt and resistance input units, downscale for process
6. Relay status and mode - If not specified, default is normally energised and single trips are set to Hi, double trips to Hi/Lo. LEDs are lit when relays are energised
7. Any options required
8. Information appropriate to any options ordered